

Kozy-World® VENT-FREE GAS-FIRED ROOM HEATER

USER'S OPERATION AND INSTALLATION MANUAL

MODELS:KW(N307,P308)-30,000 BTU/HR THERMOSTAT
AND KW(N207,P208)-20,000 BTU/HR THERMOSTAT
AND KW(N105,P106)-10,000 BTU/HR THERMOSTAT

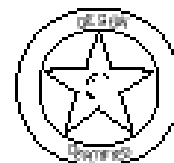
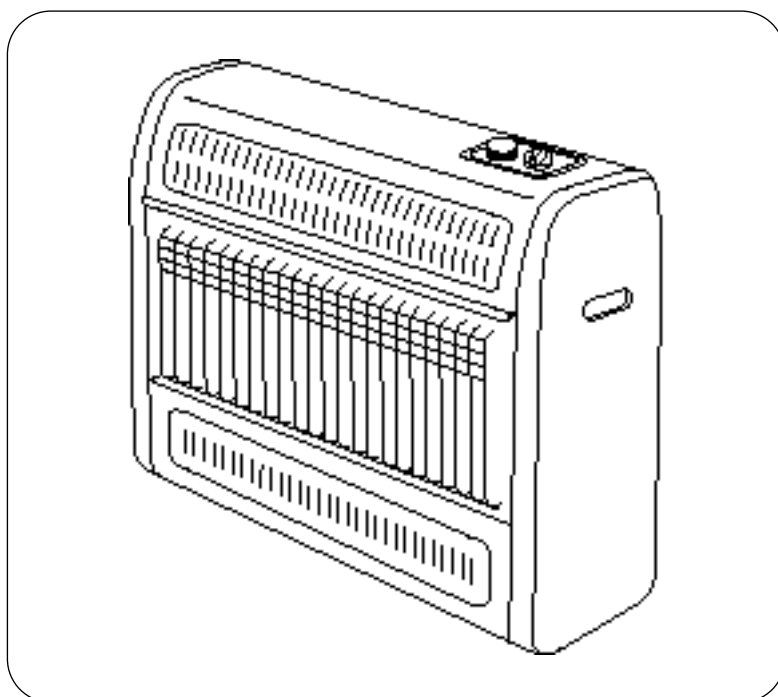

WARNING:If the information in this manual is not followed exactly, a fire or explosion may result causing property damage, personal injury, or loss of life.

- Do not store or use gasoline or other flammable vapors and liquids in the vicinity of this or any other appliance.
- **WHAT TO DO IF YOU SMELL GAS**
 - Do not try to light any appliance.
 - Do not touch any electrical switch; do not use any phone in your building.
 - Immediately call your gas supplier from a neighbor's phone. Follow the gas supplier's instructions.
 - If you cannot reach your gas supplier, call the fire department.
- Installation and service must be performed by a qualified installer, service agency or the gas supplier.

- **INSTALLER :** LEAVE THIS MANUAL WITH THE CONSUMER
- **CONSUMER :** RETAIN THIS MANUAL FOR FUTURE REFERENCE

WORLD MARKETING OF AMERICA, INC.
PO Box 192, Route 22 West, Mill Creek, PA 17060-0192
www.worldmktng.com

CONTENTS

SECTION I-	General Safety Instructions	2
SECTION II-	Product Identification	3
SECTION III-	Local Codes/National Fuel Code	3
SECTION IV-	Unpacking the Heater Package	4
SECTION V-	Product Features	4
SECTION VI-	Fresh Air for Combustion and Ventilation	4
	Installation	5
SECTION VII-	Gas Requirements	9
SECTION VIII-	Leak Checking	10
SECTION IX-	Operating the Heater	11
SECTION X-	Inspecting Burner & Pilot Burner Flames	14
SECTION XI-	Care And Maintenance	15
SECTION XII-	Troubleshooting	16
SECTION XIII	Specifications	18
SECTION XIV-	Accessories	18
SECTION XV-	Parts List	19
SECTION XVI-	Warranty Information	

☞ Model Nos. KW(N307,P308), KW(N207, P208) Series shall not be installed in a bedroom or bathroom.

☞ Model Nos. KW(N105, P106) Series shall not be installed in a bathroom.

GENERAL SAFETY INSTRUCTIONS:

SAFETY : Accidents are always tragic especially because so many of them could have been prevented with a little care and judgment. There are some basic good practices we hope you will follow for safe use of your gas-fired room heater.

IMPORTANT : **Read this user's manual carefully and completely before trying to assemble, operate, or service this heater. Improper use of this heater can cause serious injury or death from burns, fire, explosion, electrical shock, and carbon monoxide poisoning.**

Early signs of carbon monoxide poisoning resemble the flu, with headaches, dizziness, or nausea. If you have these signs, the heater may not be working properly. **Get fresh air at once!** Have heater serviced. Some people are more affected by carbon monoxide than others. These include pregnant women, people with heart or lung disease or anemia, those under the influence of alcohol, and those at high altitudes.

Begin by insuring proper installation and servicing. Follow the installation instructions provided with this product. Have your heater installed by a qualified technician. Have the installer show you where the gas supply shut off valve is located so that you know where to shut off the gas to the heater. If you smell gas, your installer has not done a proper job of checking leaks. If the connections are not perfectly seated or tightened, you may have a leak and therefore a faint gas smell. Finding a leak is not a **DO-IT-YOURSELF** procedure. Some leaks can only be found with the main burner gas on and this must be done by a qualified technician.

PRECAUTIONS:

- ⚠️ Never use natural gas in a unit designed for liquefied petroleum gases.
- ⚠️ Never use liquefied petroleum gases in a unit designed for natural gas.
- ⚠️ Check all joints and connections. To avoid the danger of fire, accident or explosion, never check a potential gas leak with an open flame.
- ⚠️ This heater shall not be installed in a bedroom or bathroom.
- ⚠️ Never install the heater in any of the following locations:
 - Recreational vehicle
 - Where curtains, furniture, clothing, or other flammable objects are less than 36 inches from the front, top, or sides of the heater
 - Fireplace
 - High traffic area
 - Drafty areas
- ⚠️ This heater needs fresh, outside air for ventilation to run properly. This heater has an oxygen depletion sensor(ODS)pilot light safety system. The ODS shuts down the heater if not enough fresh air/oxygen content(18%)is available.
- ⚠️ Never run heater in confined space. Open a door to an adjoining room to help ventilate(For air openings, see National Fuel Code).

- ☛ If heater shuts off, do not relight until you provide fresh, outside air. If heater keeps shutting off, have it serviced.
- ☛ Do not run heater where :
 - Flammable liquids or vapors are used or stored.
 - Dusty condition exists.
- ☛ Never place any objects on the heater.
- ☛ Supervise children when they are in the same room with heater, never allow them to sit, stand or play on or around the heater.
- ☛ Make sure grille guard is in place before running heater.
- ☛ Do not use heater if any part has been under water. Immediately call a qualified service technician to inspect the room heater and to replace any part of the control system and any gas control which has been under water.
- ☛ Keep appliance area clear and free from combustible materials, gasoline and other flammable vapors and liquids.
- ☛ Turn off heater and let cool before servicing. Only a qualified technician should service and repair heater.

PRODUCT IDENTIFICATION:

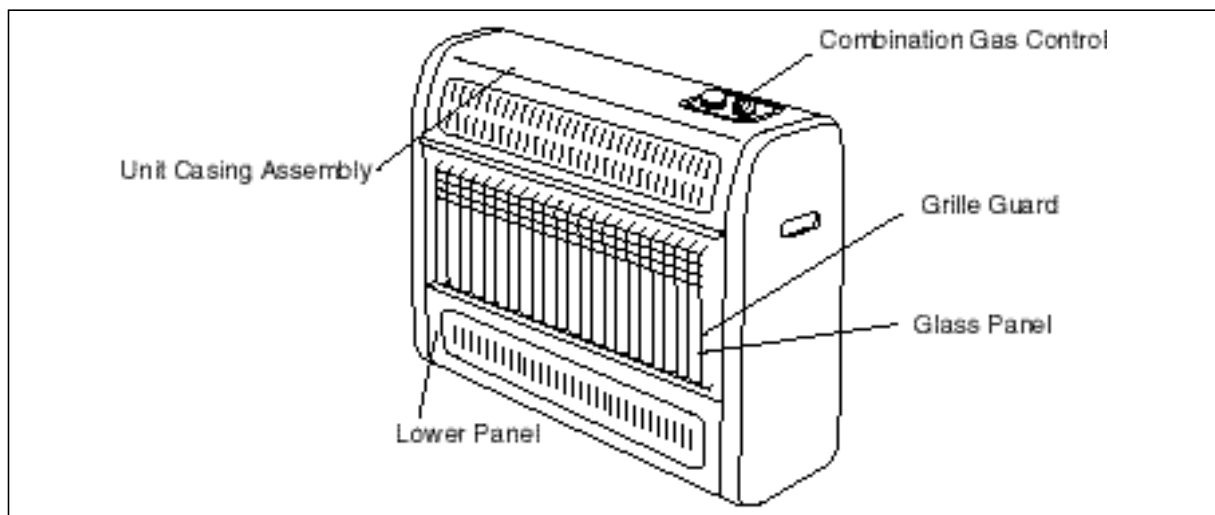

LOCAL CODES

Install and use heater with care. Follow all local codes. In the absence of local codes, use the latest edition of the National Fuel Gas Code ANSI Z223.1, also known as NFPA54*

* Available from:

American National Standards Institute, Inc.

1430 Broadway

New York, NY 10018

National Fire Protection Association, Inc.

Batterymarch Park

Quincy, MA 02269

UNPACKING:

1. Remove heater from carton.
2. Remove all protective packaging applied to heater for shipment.
3. Check heater for any shipping damage. If heater is damaged, promptly inform dealer/distributor where you bought heater.

PRODUCT FEATURES:

Safety Device

This heater has a pilot with an Oxygen Depletion Sensor Shutoff System (ODS).

The ODS pilot is a required feature for vent-free room heaters. The ODS pilot shuts off the heater if the normal air oxygen content is reduced to 18%.

Piezo Ignition System

This heater has a piezo ignitor. This system requires no matches, batteries, or other sources to light heater.

Thermostatic Heat Control

Thermostat has a sensing bulb, and a control valve. This results in the greatest heater comfort. This **can also result in lower** gas bills.

FRESH AIR FOR COMBUSTION AND VENTILATION:

 **WARNING** : This heater must have fresh air for proper operation. If not, poor fuel combustion could result. Read the following instructions to insure proper fresh air for this and other fuel-burning appliances in your home.

ADEQUATE COMBUSTION/VENTILATION AIR

All spaces in homes fall into one of the three following ventilation classifications:

- **Unusually Tight Construction** : The air that leaks around doors and windows may provide enough fresh air for combustion and ventilation. However, in buildings of unusually tight construction, you must provide additional fresh air. Unusually Tight Construction is defined as construction where:
 - Walls and ceilings exposed to the outside atmosphere have a continuous water vapor retarder with a rating of one perm or less with openings gasketed or sealed and
 - Weather stripping has been added on openable windows and doors
 - Caulking or sealants are applied to areas such as joints around window and door frames, between sole plates and floors, between wall-ceiling joints, between wall panels, at penetrations for plumbing, electrical and gas lines, and at other openings.

- **Unconfined Space**

An unconfined space whose volume is not less than 50 cubic feet per 1,000 BTU/HR of the aggregate input rating of all appliances installed in that space. Rooms communicating directly with the space in which the appliances are installed, Though the openings not furnished with doors are considered a part of the unconfined space.

- **Confined Space**

A confined space whose volume is less than 50 cubic feet for each 1,000 BTU/HR of the aggregate input rating of all appliances in that space.

⚠ WARNING : You must provide additional ventilation air in a confined space.

For proper operation of the unit, provide fresh air opening(s) to the room. Follow the National Fuel Code NFPA 54 / ANSI Z223.1, for required size of combustion and ventilation openings.

➤ **NOTICE :** A qualified service person must install heater. Follow all local codes.

➤ **CHECK GAS TYPE :** Verify the type of gas supply to be used, either natural or LP(Propane), and make sure the marking on the appliance rating plate agrees with that of the supply gas. The rating plate is located on the side of the heater, which indicates the type of gas that heater is orificed for.

➤ **ITEMS NEEDED FOR HEATER INSTALLATION:** Before installing heater, make sure you have the items listed below:

- Gas piping (check local codes.).
- Test gauge connection
- Sealant (resistant to LP gases)
- Manual shutoff valve*
- Sediment trap
- Ground joint union
- Tee joint and pipe wrench

An installer supplied, design-certified manual shutoff valve with 1/8" NPT tap connection.

LP gases installation, also requires an installer supplied, design certified gas pressure regulator.

LOCATING HEATER:

This heater is designed to be mounted on a wall. Heater can be located on floor, away from a wall. An optional floor mounting base is needed, purchase the floor mounting base from your dealer.

⚠ WARNING : Never install the heater

- in a bedroom or a bathroom
- in a recreational vehicle
- where curtains, furniture, clothing, or other flammable objects are less than 36 inches from the front, top, or sides of the heater
- as a fireplace insert

- in high traffic areas
- in windy or drafty areas

➤ **IMPORTANT :** Vent-free heaters add moisture to the air. Although this is beneficial, installing heater in rooms without enough ventilation may cause mildew formation from too much moisture content. See National Fuel Code for Fresh Air for Combustion and Ventilation.

This appliance may be installed in an aftermarket* manufacture (Mobile) home, where not prohibited by state or local codes.

*Aftermarket : Completion of sale, not for purpose of resale, from the manufacturer.

This appliance is only for use with the type of gas indicated on the rating plate. This appliance is not convertible for use with other gases.

➤ **CAUTION :**

If you install the heater in a home garage:

- Heater must be at least 18 inches above floor.
- Locate heater where moving vehicle will not hit it.

Preparing For Installation

Select a location for the heater that will provide maximum exposure of the radiant surface to the room, but will not be subjected to accidental contact.

Adequate clearance must be available around the air opening. See Figures 1 & 2 for clearances that must be maintained to the side walls, floor and horizontal surface surrounding the heater.

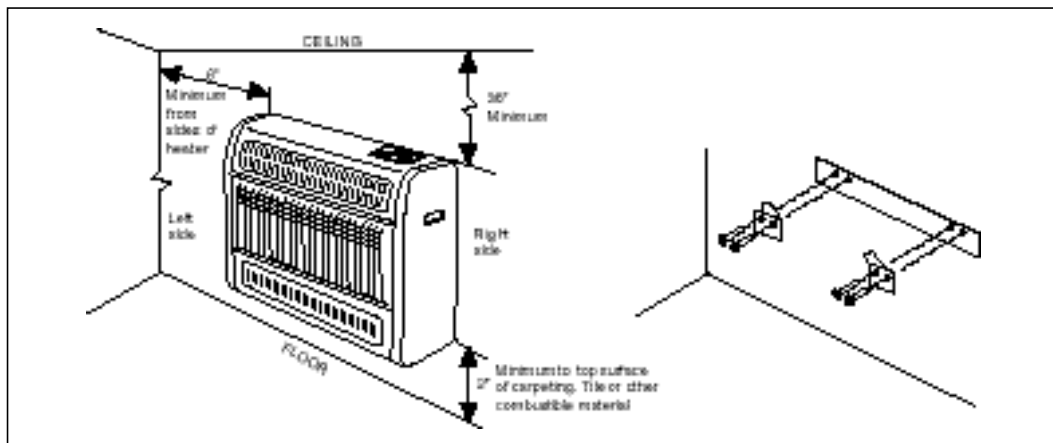

Figure 1

Figure 2

Attaching Mounting Brackets To Wall

Note: Wall anchors, mounting screws, and spacers are in hardware package. The hardware package is provided with heater

1. Install mounting brackets on wall as shown in Figure 2. Use enclosed "paper template" for proper location of holes. It may be necessary to use plastic or lead anchors for plaster walls.
2. Drill holes at marked locations using 9/64" drill bit.
3. Insert mounting screws through bracket and into wall studs.
4. Tighten screws until mounting bracket is firmly fastened to wall studs.

Attaching to wall anchor method

For attaching mounting bracket to hollow walls(wall areas between studs) or solid walls (concrete or masonry):

1. Drill holes at marked locations using 5/16" drill bit. For solid walls (concrete or masonry), drill at least 1 inch deep.
2. Insert the plastic anchor as shown in Figure 3 below:

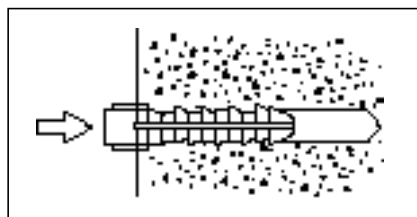

Figure 3

3. Tap anchor flush to wall as shown in Fig.4

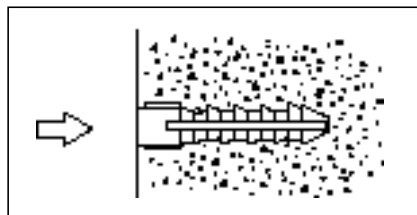

Figure 4

4. Insert mounting screws through each bracket and into wall anchors.
5. Tighten screws until mounting bracket is firmly fastened to wall.

Installing Bottom Mounting Screws

1. Locate two bottom mounting holes. These holes are near bottom on back panel of heater (See Figure 5.).
2. Mark screw locations on wall.
3. Remove heater from mounting bracket.
4. If installing bottom mounting screws into hollow or solid wall, install wall anchors. Follow steps 1 through 4 under, "Attaching To Wall Anchor Method", page 7. If installing bottom mounting screw into wall stud, drill holes at marked locations using 9/64" drill bit.
5. Replace heater onto mounting bracket.
6. Place spacers between bottom mounting holes and wall anchor or drilled hole.
7. Hold spacer in place with one hand. With other hand, insert mounting screw through bottom mounting hole and spacer. Place tip of screw in opening of wall

anchor or drilled hole.

8. Tighten both screws until heater is firmly secured to wall. Do not over tighten.

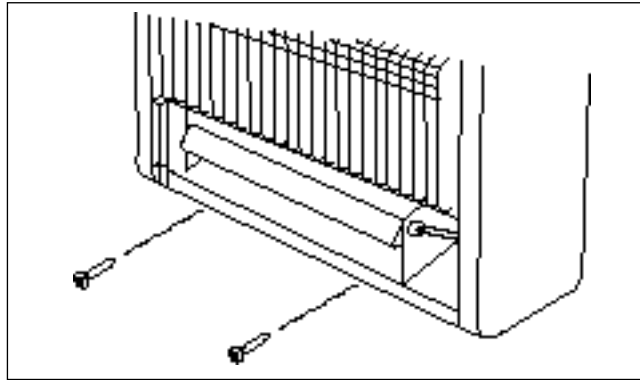

Figure 5

1. Clearance requirements from surface of carpeting, tile or other combustible material (See Figure 1.).

Wall Mounted & Floor Mounted With Base Provided

Rear	0 Inches
Sides	6 Inches
Top	36 Inches
Floor	2 Inches

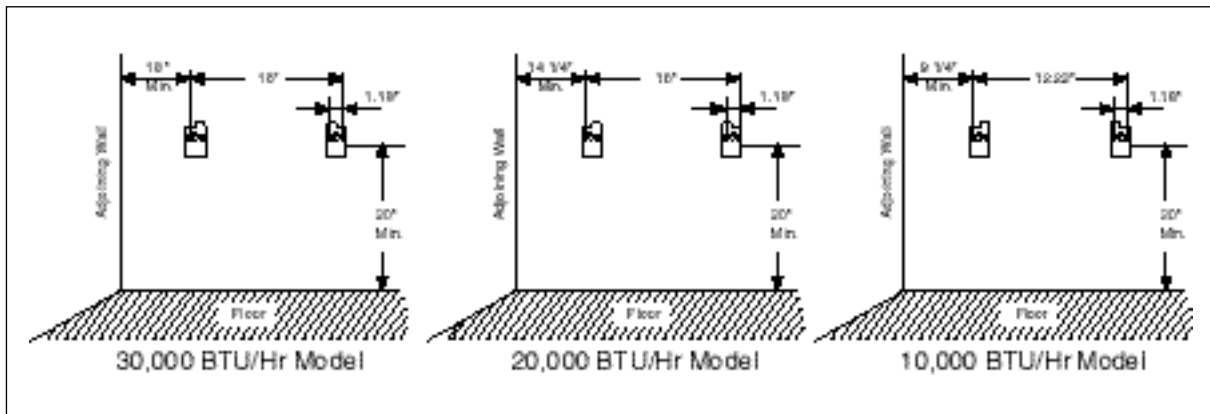

Figure 6

NOTICE:

Maintain the minimum clearances shown in Figure 1, but you can provide greater clearances from floor, ceiling and adjoining wall.

2. After mounting brackets are installed, hang heater on mounting brackets in holes provided at the rear of heater (See Figure 7.).

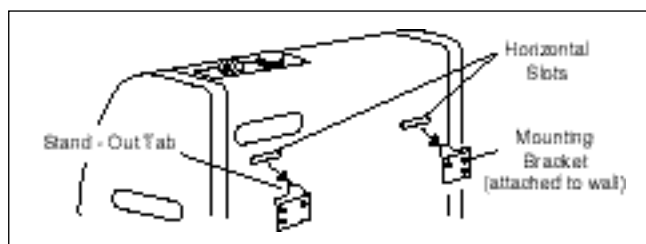

Figure 7

3. Installation and repair should be done by a qualified service person. The room heater should be inspected before use and at least annually by a professional service person. More frequent cleaning may be required due to excessive lint from carpeting and other materials. It is imperative that the control compartments, burners and circulating air passageways of the heater be kept clean.

CONNECTING TO GAS SUPPLY :

⚠️ WARNING : Never connect an unregulated gas line to the heater.

An installer supplied, design certified gas pressure regulator must be installed to bring the gas supply pressure down to 14 inches of water column.

➡️ IMPORTANT : Check gas line pressure before connecting heater to gas line. Gas line pressure must not be higher than 14 inches of water. If gas line pressure is higher, heater gas pressure regulator damage could occur.

⚠️ CAUTION : Use only new, black iron or steel pipe. Internally-tinned copper tubing may be used in certain areas. Check your local codes. Use pipe of large enough diameter to allow proper gas volume to heater. If pipe is too small, undue pressure loss will occur.

Typical Gas Supply Pipe Diameters

10,000 BTU/HR Model	3/8" or greater
20,000 BTU/HR Model	3/8" or greater
30,000 BTU/HR Model	3/8" or greater

⚠️ CAUTION:

Use pipe joint sealant that is resistant to liquefied petroleum gases.

Install sediment trap in supply line as shown in Figure 8 Gas Connection. Locate sediment trap where it is within reach for cleaning. Locate sediment trap where trapped matter is not likely to freeze. A sediment trap traps moisture and contaminants. This keeps them from going into heater controls. If sediment trap is not installed or is installed wrong, heater may not run properly.

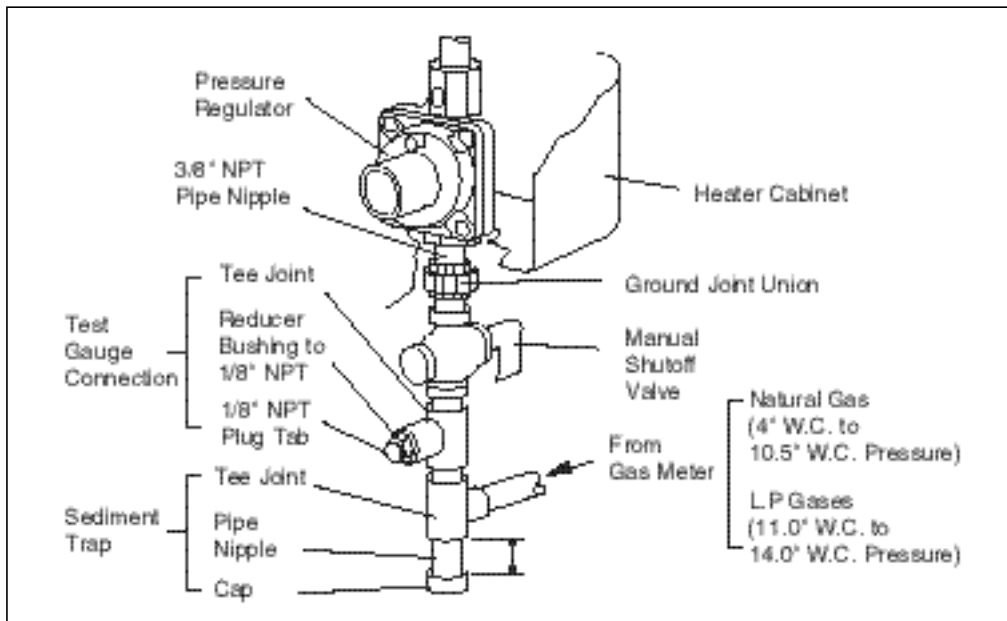

Figure 8

LEAK CHECKING:

GENERAL : Although all gas connections on the heater are leak tested at the factory prior to shipment, a complete gas tightness check must be performed at the installation site due to possible mishandling in shipment, or excessive pressure unknowingly being applied to the appliance. Periodically check the whole system for leaks, or immediately check if the smell of gas is detected.

BEFORE TESTING

Do not smoke while leak testing. Extinguish all open flames.

Make a soap solution of one part liquid detergent and one part water. You will need a spray bottle, brush or a piece of rag to apply the solution to the fittings.

For LP units, check with a full cylinder.

CAUTION : NEVER LEAK TEST WITH AN OPEN FLAME

PRESSURE TESTING-GAS SUPPLY PIPING SYSTEM

- The appliance and its individual shutoff valve must be disconnected from the gas supply piping system during any pressure testing of that system at test pressures in excess of 1/2 psig.
- The appliance must be isolated from the gas supply piping system by closing its individual manual shutoff valve during any pressure testing of the gas supply piping system at test pressures equal to less than 1/2 psig.

LEAK TESTING HEATER GAS CONNECTIONS:

1. Open manual shutoff valve.
2. Open main gas valve located near gas meter.
3. Make sure control knob of heater is in the OFF position.
4. Check all joints from manual gas valve up to gas control and including the manifold assembly. Apply the soap solution around the connections, valve and tubing. Soap bubbles will appear where a leak is present.
5. If a leak is present, immediately turn off gas supply, tighten any leaky fittings, turn gas on and recheck.
6. To check burner and safety valve, the burner must be lit (See operating Instructions.). Check the rest of the connections for leaks.
7. Turn off the heater (See Instructions.).

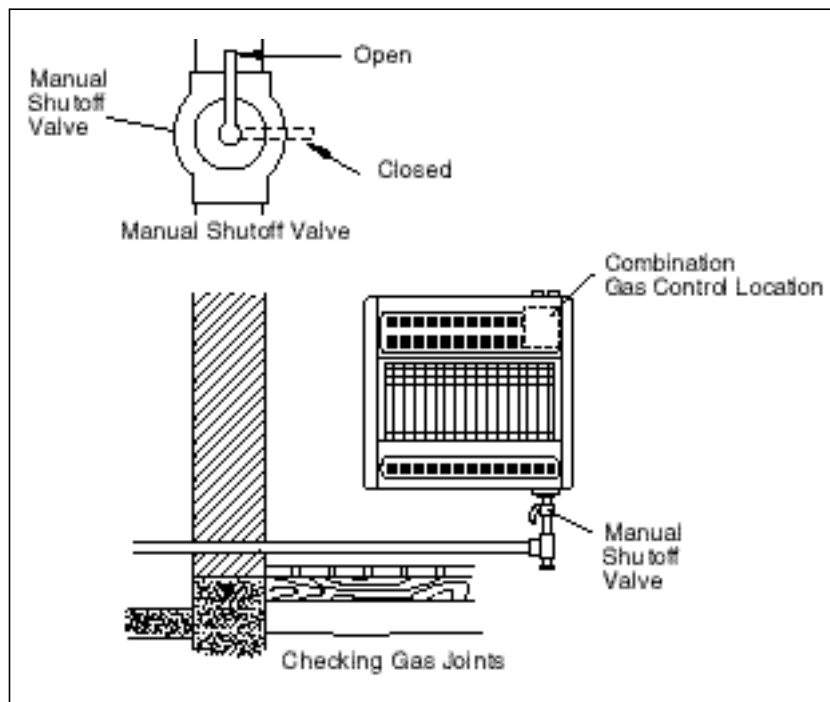

➤ NOTE:

Never use an open flame to check for a leak. Apply a mixture of liquid soap and water to all joints. Bubbles forming show a leak. Correct all leaks at once.



OPERATING HEATER:

⚠ WARNING:

- Before lighting, smell all around the appliance area for gas. Be sure to smell next to the floor because some gas is heavier than air and will settle on the floor. If you smell gas, follow the Safety Instructions on the front page and under Section I.

- Use only your hand to push in or turn the gas control knob. Never use tools. If the knob will not push in or turn by hand, don't try to repair it, call qualified service technician or gas supplier. Force or attempted repair may result in a fire or explosion.
- Do not use this appliance if any part has been under water. Immediately call a qualified service technician to inspect the appliance and replace any part of the control system and any gas control component which has been under water.

LIGHTING INSTRUCTIONS:

1. Read the aforementioned safety information.
2. Make sure manual shutoff valve is fully open.
3. Push in gas control knob slightly and turn clockwise  to the **OFF** position.
4. Wait five minutes to clear any gas. Then smell for gas, including near the floor. If you smell gas, follow the safety information on the front page. If you don't smell gas, go to the next step.
5. Push in and turn gas control knob counterclockwise  to IGN PILOT. This will light the pilot. The pilot can be seen through the glass panel. If needed, keep pressing and turning the control knob counterclockwise until the pilot lights.

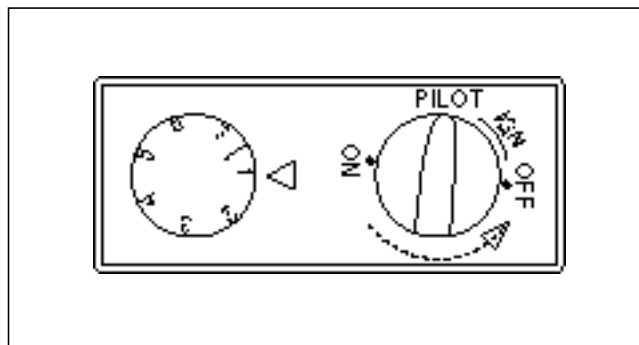

- **NOTE :** If pilot does not stay lit, refer to troubleshooting Section XII. Also, contact a qualified service person, or gas supplier for repairs. Until repairs are made, light pilot with match. To light pilot with match, see the following manual lighting instructions.
6. Keep control knob pressed in for 30 seconds after lighting pilot. After 30 seconds, release control knob.

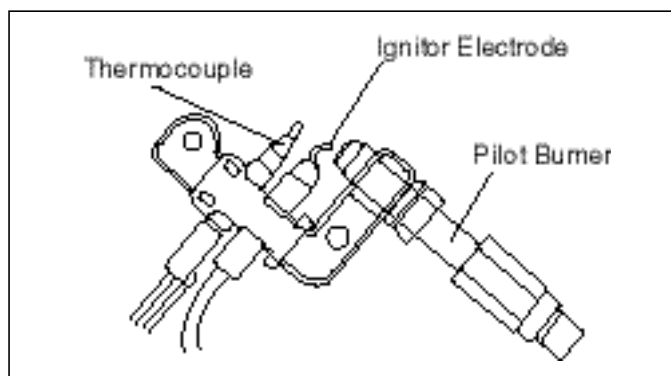

7. If pilot goes out, repeat steps 3 through 6. This heater has a safety interlock system. Wait one(1) minute before relighting pilot.
8. When the pilot is lit, turn gas control knob to ON. Turn thermostat control knob counterclockwise  to desired heating level. The main burner should light. Set control knob to heat level between 7 and 1.

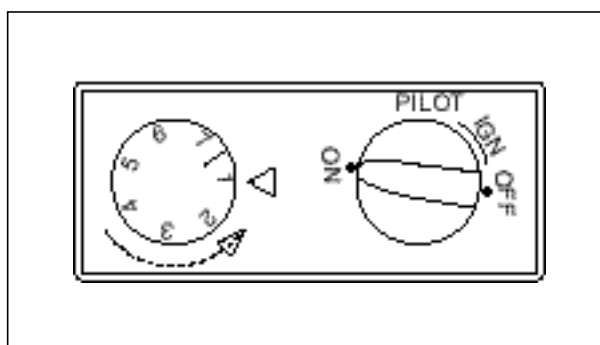

 **CAUTION :** Do not try to adjust heating levels by using the manual shutoff valve.

TURNING OFF GAS TO HEATER

Shutting Off Heater

- Turn control knob clockwise  to the OFF position.

Shutting Off Burner Only (Pilot stays lit)

- Turn control knob clockwise  to the PILOT position.

THERMOSTAT CONTROL OPERATION

The thermostat used on these models differs from standard thermostats. Standard thermostats simply turn the burner on and off. The thermostat used on this heater senses the room temperature. The thermostat adjusts the amount of gas flow to the burner. This increases or decreases the burner flame height/input rating. At times the room may exceed the set temperature.

If so, the burner will shut off. The burner will cycle back on when room temperature drops below the set temperature.

Note : The thermostat sensing bulb measures the temperature of air near the heater cabinet. This may not always agree with room temperature (depending on housing construction, installation location, room size etc.). Frequent use of your heater will let you determine your own comfort levels.

MANUAL LIGHTING INSTRUCTIONS

1. Remove lower front panel.
2. Follow steps 1 through 4 as stated under Lighting Instructions.
3. Press and turn control knob counterclockwise  to the PILOT position.
4. With control knob pressed in, strike match, hold match to pilot until pilot lights.
5. Keep control knob pressed in for 30 seconds after lighting pilot. After 30 seconds, release control knob.
6. Replace lower front panel.

INSPECTING MAIN BURNER AND PILOT BURNER

Pilot Flame Pattern

The following figures show a correct and incorrect flame patterns. The incorrect flame is not touching the thermocouple. This will cause a nuisance shut down.

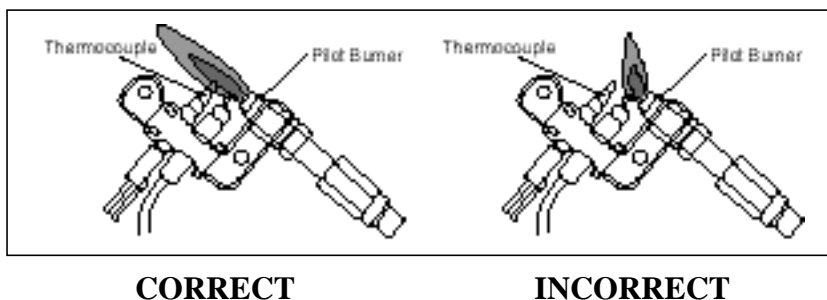

If pilot flame pattern is incorrect as shown above, turn heater off and refer to troubleshooting guide.

Burner Flame Pattern

Correct and incorrect flame patterns are shown as below. The incorrect burner flame pattern shows yellow tipping of the flame.

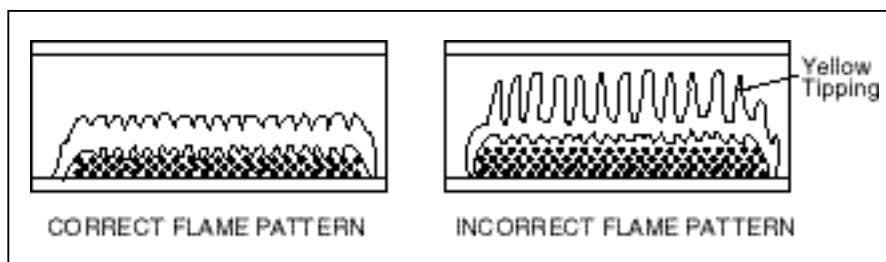

⚠️ WARNING :

If yellow tipping occurs, your heater could produce increased levels of carbon monoxide. If burner flame pattern shows yellow tipping, follow instructions at bottom of this page.

➤ **NOTICE :** Do not mistake orange flames with yellow tipping. Dirt or other particles etc. enter the heater and cause transient patches of orange flame.

CARE AND MAINTENANCE :

Dust, lint or debris may affect heater performance. The heater draws air into it during normal operation. In the process dust, lint or debris will be drawn into the heater and spider webs can build up during off season. Keep burner, gas control and combustion and circulating air passageways clean. Inspect or have these areas inspected annually at the beginning of the heating season by a qualified service person. Room heater may require frequent cleaning due to excessive lint or debris depending upon the surroundings.

BEFORE CLEANING - Ensure the gas supply is off and the gas control knob is in the off position. Make sure the heater is cool.

WARNING:DANGER OF BODILY INJURY

If fan assembly accessory is used, turn off power supply at disconnect switch or service panel before removing any access panels from heater.

BURNER AND ODS PILOT CLEANING - Clean the exterior with soft bristle brush, vacuum cleaner pressurized air. Never use a wooden toothpick as it may break off and clog the ODS pilot or main burner port.

Use a flashlight to inspect the main burner inlet to ensure it is not blocked. If obstruction can be seen, use a metal wire coat hanger that has been straightened out.

In order to clean ODS pilot orifice, use pressurized air to blow dust out. Sometimes blowing air backwards through the pilot will get rid of the accumulated dirt. If that does not work, blow out any dust through primary air openings of pilot assemblies(Daemyeong has two openings; one beneath the bimetal strip and the second one opposite from bimetal strip. Use the one wide open, do not try to lift the bimetal.).

AIR PASSAGEWAYS AND UNIT CASINGS - Use a vacuum cleaner or pressurized air to clean the combustion and circulating air passageways and dampened cloth to clean the cabinet/casing.

TROUBLESHOOTING:

PROBLEM	POSSIBLE CAUSE	WHAT TO DO
When control knob is pressed in and turned counterclockwise to ignition, there is no spark at ODS pilot.	<ol style="list-style-type: none"> 1. Ignitor electrode positioned wrong. 2. Ignitor electrode broken. 3. Ignitor cable pinched or broken. 4. Ignitor cable not connected to ignitor electrode. 	<ol style="list-style-type: none"> 1. Replace Ignitor electrode. 2. Replace electrode. 3. Free ignitor cable, if damaged replace it. 4. Connect cable to electrode.
When control knob is pressed in and turned counterclockwise to ignition/pilot position, there is spark but no ignition.	<ol style="list-style-type: none"> 1. Gas supply turned off. 2. Control knob not in pilot position. 3. Control knob not pressed in while in pilot position. 4. ODS pilot is clogged. 5. Air in gas Lines. 	<ol style="list-style-type: none"> 1. Turn on gas supply. 2. Turn control knob to pilot position. 3. Press in control while in pilot position. 4. Call a qualified person 5. Purge gas lines and repeat ignition operation.
ODS pilot lights but flame goes out when control knob is released.	<ol style="list-style-type: none"> 1. Control knob not pressed long enough. 2. Safety interlock is triggered. 3. Pilot flame not touching the thermocouple. Problem could be result of one or both of the following: <ul style="list-style-type: none"> • Partially clogged ODS pilot orifice. • Low gas pressure. 4. Thermocouple damaged. 5. Thermocouple connection loose at gas control valve. 6. Gas control valve damaged. 	<ol style="list-style-type: none"> 1. After ODS pilot lights, keep control knob pressed in approx. 30 sec. 2. Wait a minute, repeat ignition operation. 3. Contact your gas company or gas supplier or qualified service person. 4. Replace thermocouple. 5. Hand tight until snug then tighten 1/4 turn with a wrench. 6. Replace gas control.
Burner does not light after ODS pilot is lit	<ol style="list-style-type: none"> 1. Burner orifice clogged. 2. Gas supply pressure is very low. 	<ol style="list-style-type: none"> 1. Clean burner orifice. 2. Contact the Gas Co.
Delayed ignition	<ol style="list-style-type: none"> 1. Main burner carry over ports clogged. 2. Gas supply pressure is very low. 	<ol style="list-style-type: none"> 1. Clean main burner ports. 2. Call your gas supplier.

PROBLEM	POSSIBLE CAUSE	WHAT TO DO
Burner backfiring during operation	<ol style="list-style-type: none"> 1. Burner orifice is clogged. 2. Burner ports damaged. 	<ol style="list-style-type: none"> 1. Clean burner orifice. 2. Replace burner.
Yellow flames during burner operation	<ol style="list-style-type: none"> 1. Not enough air 	<ol style="list-style-type: none"> 1. Check air passageways and burner for dirt and debris(see care & maintenance.).
Slight smoke and odor during initial operation	<ol style="list-style-type: none"> 1. Residues from manufacturing processes. 	<ol style="list-style-type: none"> 1. Will stop after a few hours of operation.
Heater produces a whistling noise when burner is lit.	<ol style="list-style-type: none"> 1. Air passageways blocked. 2. Air in gas line 	<ol style="list-style-type: none"> 1. Check minimum installation clearances and air passageways for debris. 2. Operate burner until the air is completely purged.
Heater produces a clicking noise just after burner is lit or turned off.	<ol style="list-style-type: none"> 1. Metal expanding and contracting, respectively. 	<ol style="list-style-type: none"> 1. This is common with heaters. If noise is excessive, contact a qualified person.
Gas odor even when control knob is in OFF position.	<ol style="list-style-type: none"> 1. Gas leaks. See front page Warnings. 2. Gas control defective 	<ol style="list-style-type: none"> 1. Locate and correct leaks immediately. 2. Replace gas control
Gas odor during combustion	<ol style="list-style-type: none"> 1. Foreign matter in gas or on burner ports. 2. Heater burning vapors from paint, impurities in air. 3. Gas leaks. See front page Warnings. 	<ol style="list-style-type: none"> 1. Check gas passage way and burner. 2. Ventilate room, stop storing and using odor causing products near the heater. 3. Locate and correct leaks immediately.
Heater shuts off on ODS	<ol style="list-style-type: none"> 1. Not enough fresh air is available. 2. Low gas pressure 3. ODS pilot partially clogged. 	<ol style="list-style-type: none"> 1. Open window. 2. Contact your gas company. 3. Clean the pilot.

SPECIFICATIONS:

MODELS	KW(N307,P308)		KW(N207,P208)		KW(N105,P106)	
	N307	P308	N207	P208	N105	P106
INPUT RATING (BTU/HR, Variable)	30,000/15,000	30,000/15,000	20,000/10,000	20,000/10,000	10,000/5,000	10,000/5,000
TYPE OF GAS	NATURAL	LP GASES	NATURAL	LP GASES	NATURAL	LP GASES
REGULATOR PRESSURE SETTING	3.0" W.C.	8.0" W.C.	3.0" W.C.	8.0" W.C.	3.0" W.C.	8.0" W.C.
INLET GAS SUPPLY PRESSURE: MAXIMUM MINIMUM	10.5" W.C. 4.0" W.C.	14.0" W.C. 11.0" W.C.	10.5" W.C. 4.0" W.C.	14.0" W.C. 11.0" W.C.	10.5" W.C. 4.0" W.C.	14.0" W.C. 11.0" W.C.
SIZE OF HEATER	23.8" × 25.7" × 8"		23.8" × 18.3" × 8"		23.8" × 14.6" × 8"	
WEIGHT	30LBS		22LBS		18LBS	

➤ **NOTE :** For altitudes above 2,000 feet, reduce the input rating(BTU/HR)4% for each 1,000 feet above sea level.

"DO NOT USE THIS HEATER AT AN ELEVATION ABOVE 4,500 FEET"

OPTIONAL ACCESSORIES: Purchase these heater accessories from your local distributors/dealers. If they can not furnish these items, call World Marketing of America, Inc. @1-814-643-2299 for more detailed information.

FLOOR MOUNTING BASE : No. 20-5231 may be used for MODEL(KWN307, KWP308).

No. 20-5221 may be used for MODEL(KWN207, KWP208).

No. 20-5211 may be used for MODEL(KWN105, KWP106).

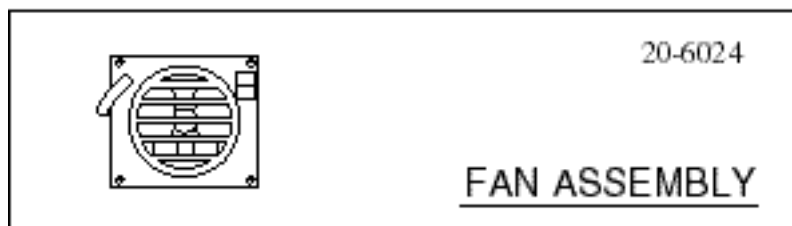
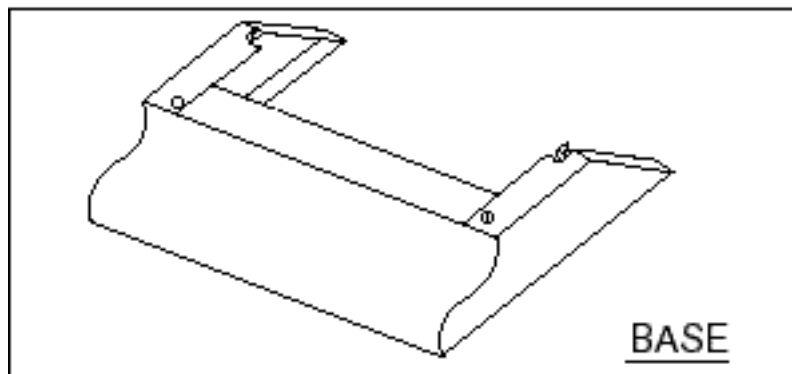

PARTS LIST

PARTS LIST

ITEM NO.	DESCRIPTION	PART NO. FOR		
		KW(N307, P308)	KW(N207, P208)	KW(N105, P106)
1.	Unit Casing Assembly	REF-2A0054	REF-2A0055	REF-2A0073
2.	Main Burner Assembly	20-0131(2A0079)	20-0120(2A0080)	20-0111(2A0133)
3.	Firebox Assembly	20-0139(3A1033a)	20-0139(3A1033b)	20-0119(1A0072)
4.	Glass Panel	20-0530(3A1018a)	20-0520(3A1018b)	20-0510(3A0170)
5.	Glass Holder-U	20-8031(3A1011a)	20-8021(3A1011b)	20-8015(3A0174)
6.	Glass Holder-L	20-8032(3A1012a)	20-8022(3A1012b)	20-8016(3A0173)
7.	Grille Guard	20-5430(1A0040)	20-5420(1A0041)	20-5400(1A0071)
8.	Lower Panel	REF-1A1013	REF-1A1023	REF-1A0070
9.	Valve Bracket	REF-3A1025	REF-3A1025	REF-3A1025
10.	Combination Gas Control	20-1037/20-1038 (GV30 30N3/L8)	20-1027/20-1028 (GV30 20N3/L8)	20-1041/20-1042 (GV30 10N3/L8)
11.	Burner Support-L(R)	REF-2A0094	REF-2A0094	REF-2A0094
12.	Cover Heat	REF-1A0026	REF-1A0027	REF-1A0135
13.	Pressure Regulator(3/8")[NG:3",LP:8"]	20-9957/20-9958 (DR40T3KN/L)	20-9951/20-9950 (DR40T2KN/L)	20-9941/20-9940 (DR40T2PN/L)
14.	Inlet Tubing(3/8") Assembly	REF-	REF-	REF-
15.	Outlet Tubing-(5/16") Assembly	REF-	REF-	REF-
16.	Nozzle Holder	REF-4A1027	REF-4A1027	REF-4A1027
17.	Nozzle Holder Nut	REF-4A1028	REF-4A1028	REF-4A1028
18.	Nozzle	20-4023/20-4022	20-4021/20-4020	REF/REF
19.	Wall Mounting Bracket-L(R)	20-9801(3A1010)	20-9801(3A1010)	20-9801(3A1010)
20.	Connector-A	REF-4A1020	REF-4A1020	REF-4A1020
21.	Connector-B	REF-4A1021	REF-4A1021	REF-4A1021
22.	Connector-C	REF-4A1022	REF-4A1022	REF-4A1022
23.	ODS Pilot Tubing(3/16") Assembly	REF-	REF-	REF-
24.	ODS Pilot Assembly (Daemyeong Korea)	20-3097/20-3098 (DS98JN/L02)	20-3097/20-3098 (DS98JN/L02)	20-3097/20-3098 (DS98JN/L02)
24-1.	Electrode	"	"	"
24-2.	Thermocouple	"	"	"
25.	ODS Mounting Screw	20-9605#30	20-9605#30	20-9605#30
26.	Regulator Fix Screw	20-9604#31	20-9604#31	20-9604#31
27.	Wall Mounting Screw	20-9607#32	20-9607#32	20-9607#32
28.	Screw	20-9606#29	20-9606#29	20-9606#29